

# SIGNUM 8

SLEEK AND AESTHETIC  
HIGH CEILING CYLINDER

### Housing

Diameter : Ø8.26" | Height : 9.25" | Weight : 11.02 lbs

### Material

Housing: High Pressure Die-Cast Aluminum

Lens: Clear Polycarbonate

### Power Input

45W | 120-277V

### Lumen Output

4,220 lm (45W)

### Dimming

Standard 0-10V: Dims to 10%

Superior 0-10V: Dims to 1%

DMX: High resolution dims to 0.1% (Supports ANSI E1.20 RDM protocol)

TRC: Line-voltage phase control, dims to 1% (120V only)

### Color Quality

CRI 85

### Rated Life

> 100,000 Hours (L70)

### Finish



Black



White

### Color Temperature



2700K



3000K



3500K



4000K



5000K

### Optics



25°



40°



60°



Wide

### Mounting



Stem  
Mount



Adjustable  
Cable



Surface  
Mount



Wall  
Mount



Yoke  
Mount

### Warranty

5 Year limited warranty

### Listing



## Dual Chamber Design For Maximum Performance

The Signum 8 is a 8-inch aperture cylinder that feature a lumen package of 4,220 lm. Compatible with a wide variety of mounting, dimming and optic selections. Perfect for general illumination and high ceiling applications.

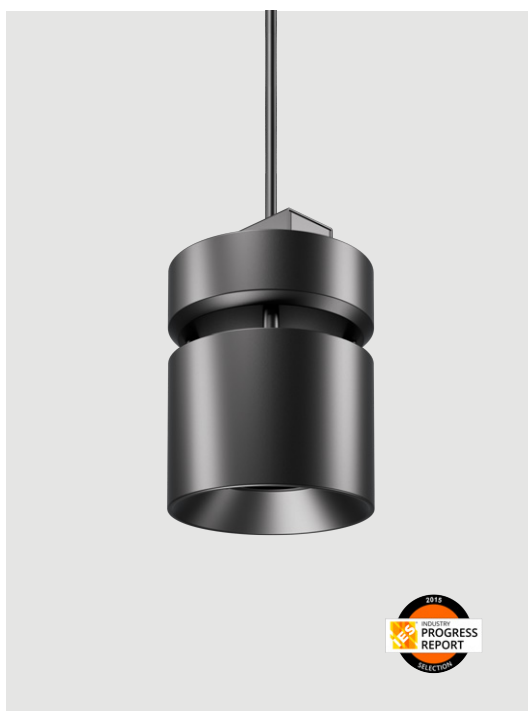

SPECIFICATION SHEET

**SIGNUM 8** SLEEK AND AESTHETIC HIGH BAY CYLINDER



**SPECIFICATION**

<b>PROJECT NAME</b>	<b>DATE</b>
<input type="text"/>	<input type="text"/>
<b>CATALOG #</b>	<b>QUANTITY</b>
<input type="text"/>	<input type="text"/>

The product configurator function on this page works only with the latest version of Chrome or Adobe Acrobat Reader.

<input type="text" value="SS8"/>	<b>MODEL</b>	<b>SIGNUM 8</b>		
<input type="text" value="45"/>	<b>WATTAGE</b>	<b>45</b> 45W		
<input type="text"/>	<b>CCT / CRI</b>	<b>278</b> 2700K / CRI 85 <b>408</b> 4000K / CRI 85	<b>308</b> 3000K / CRI 85 <b>508</b> 5000K / CRI 85	<b>358</b> 3500K / CRI 85
<input type="text" value="UNV"/>	<b>VOLTAGE</b>	<b>UNV</b> 120 – 277V		
<input type="text"/>	<b>DIMMING</b>	<b>STV</b> Standard 0-10V dims to 10% <b>DMXR</b> DMX dims to 0.1% (RJ45 Sockets)	<b>SPV</b> Superior 0-10V dims to 1% <b>TRC</b> <sup>1</sup> Line-voltage phase control, dims to 1%	<b>DMX</b> DMX dims to 0.1% (XLR Sockets)
<input type="text"/>	<b>BEAM ANGLE</b>	<b>25</b> 25° <b>WD</b> Wide	<b>40</b> 40°	<b>60</b> 60°
<input type="text"/>	<b>FINISH</b>	<b>BLK</b> Black	<b>WHT</b> White	
<input type="text"/>	<b>MOUNTING</b>	<b>SUM</b> Surface Mount <b>AD10</b> Adjustable Cable 10ft <b>SAD10</b> Sloped Adjustable Cable 10ft	<b>ST2</b> Stem 2ft <b>WLM</b> <sup>2</sup> Wall Mount	<b>ST4</b> Stem 4ft <b>YKM</b> Yoke Mount
<input type="text"/>	<b>ACCESSORIES</b>	<b>SPD</b> <sup>3</sup> Surge Protector <b>FCS</b> Field Cut Stem Adapter Kit	<b>EMP</b> Remote Emergency Pack	<b>CT</b> Conduit Mount

CLEAR FORM

<sup>1</sup> Option is only compatible with 120V  
<sup>2</sup> Wall Mount DMX wiring is through 3 DMX Positive / Negative / Common wires  
<sup>3</sup> Surge protector for up to 10KV. Applicable for unstable mains or facilities using high power machineries

SPECIFICATION SHEET

**SIGNUM 8** SLEEK AND AESTHETIC HIGH BAY CYLINDER



**TECHNICAL DETAILS**

**Electrical**

- 4,220 lm (45W)
- Power Input: Universal (120-277V)
- Operating Temperature: -13°F~112°F
- Surge Protection: Built-in is 4KV
- Power Factor Greater than 0.9
- Remote Emergency Pack: Bodine BSL20B2UEK55C111

**LED Features**

- Color Temperature: 2700K, 3000K, 3500K, 4000K, 5000K
- CRI 85
- Long lasting LED luminaire tested under TM21 lumen maintenance L70 @ 100,000 Hrs

**Optics**

- Precision molded high transmittance clear PC lens
- Beam Angle: 25°, 40°, 60°, WD

**Advanced Dimming**

- Proprietary VX Driver™ is incorporated to all dimming options for video flicker-free lighting
- Standard 0-10V: Dims to 10%
- Superior 0-10V: dims to 1%
- DMX: high resolution dims to 0.1% (Supports ANSI E1.20 RDM protocol)
- TRC: Line-voltage phase control, dims to 1% (120V only)

**Housing**

- Diameter: Ø8.26"
- Height: 9.25"
- Material: High Pressure Die-Cast Aluminum, PC Lens
- Weight: 11.02 lbs

**Mounting**

- Surface Mount
- Stem 2ft or 4ft; 37° Swivel Canopy Included
- Adjustable Cable 10ft
- Wall Mount
- Yoke Mount
- Sloped Adjustable Aircraft Cable 10ft

**Warranty**

- 5-year limited warranty

**Listing**

- ETL Dry Location Listed
- CE
- UKCA

**PERFORMANCE SUMMARY\***

Delivered Lumens					
CCT/WATTAGE	2700K	3000K	3500K	4000K	5000K
<b>45W</b>	3,230lm	3,350lm	3,490lm	3,770lm	4,220lm

Current Consumption		
WATTAGE / VOLT	120V	277V
<b>45W</b>	0.47A	0.2A

\*Beam Angle: 25° \*Tolerance ±8%

Emergency Pack Lumen Output Table				
CCT	2700K	3000K	4000K	5000K
<b>LUMEN</b>	1,640lm	1,760lm	1,890lm	1,950lm

**PHOTOMETRICS**

Below is a typical photometric representation of the Signum 8 fixture. Please download IES files to ensure exact photometric value.

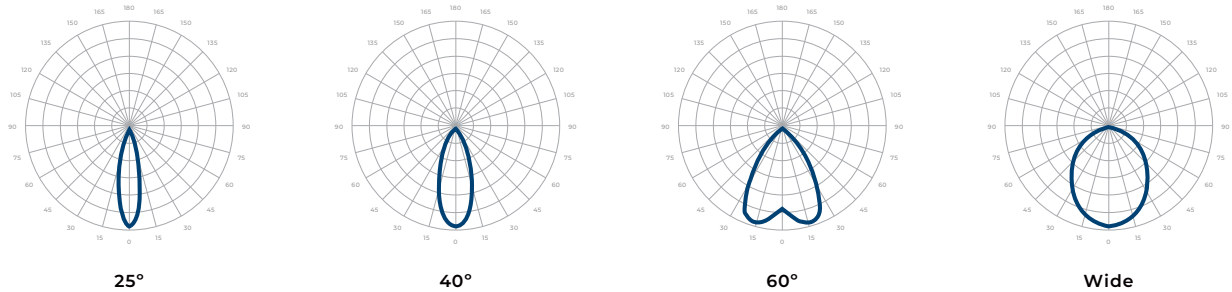

**DMX REQUIREMENTS**

The Signum 8 fixture with DMX is a **single channel dmx** unit. When placing an order, please indicate DMX address. (The DMX address will be listed on the back of the fixture). Do not connect more than 32 fixtures per DMX daisy chain.

The fixture can be connected with RJ45 or XLR sockets. DMX cables **are not** included; please refer to compatible DMX cabling list for more information. The final fixture on each daisy chain should be terminated by the use of a DMX terminator purchased from a 3rd party or from Meteor.

CONNECTION	RJ45 (CAT5e)	5-PIN XLR
Common	WHITE/BROWN(PIN7) & BROWN (PIN 8)	PIN 1
Signal -	ORANGE (PIN 2)	PIN 2
Signal +	WHITE/ORANGE (PIN 1)	PIN 3
Spare	-	PIN 4
Spare	-	PIN 5

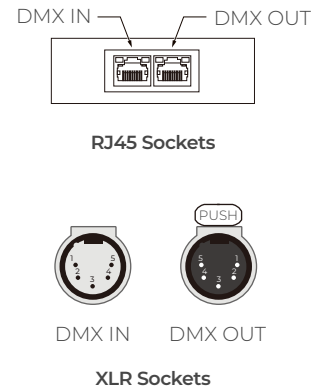

**COMPATIBLE DMX CABLING LIST**

DMX uses a cable consisting of two twisted pairs plus a shield to carry data. The cable must be specifically impedance matched for the digital DMX signal, meaning that microphone cable or other non-rated cable **must not be used to carry DMX**. Network cable (Cat5, 5e or 6 cable) may be used to carry DMX in an installation; however special consideration must be given to shielding and termination. Under no circumstances should solid core cable like Cat5 be terminated into a screw down connector.

Meteor recommends the use of Belden 9729 or Belden 9841 for DMX installation. Belden 9729/9841 is a two pair cable, which allows for a spare pair for 'out and back' type terminations if needed. Below is a list of other compatible Belden cables.

SPECIFICATION SHEET

**SIGNUM 8** SLEEK AND AESTHETIC HIGH BAY CYLINDER



**COMPATIBLE TRC DIMMER LIST**

PART NO.					
Lutron S-603PG	Lutron DVCL-153P	Lutron DVLV-600P	Lutron TGCL-153P	Lutron S-600P	Lutron DVELV-303P
Lutron SELV-300P	Lutron TG-600P	Lutron DVLV-600P	Lutron LG-600P	Lutron CT-103P	Lutron MAELV-600
Lutron FAELV-500	Leviton IPI06-1LZ	Leviton 6631-2	Leviton VPE06	Leviton 6683-IW	Leviton 6161
Leviton 6633-P	Leviton IPE04	Cooper DLC03P	Cooper SLC03P	Cooper DAL06P	Lightolier ZP260QEW

**DIMENSIONS**

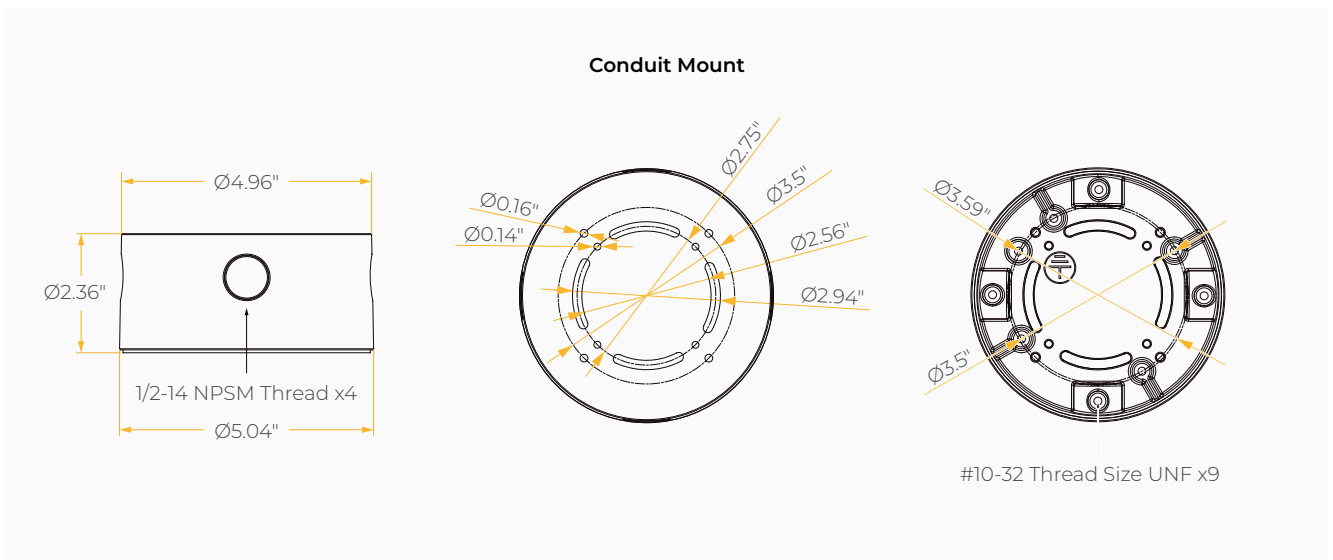
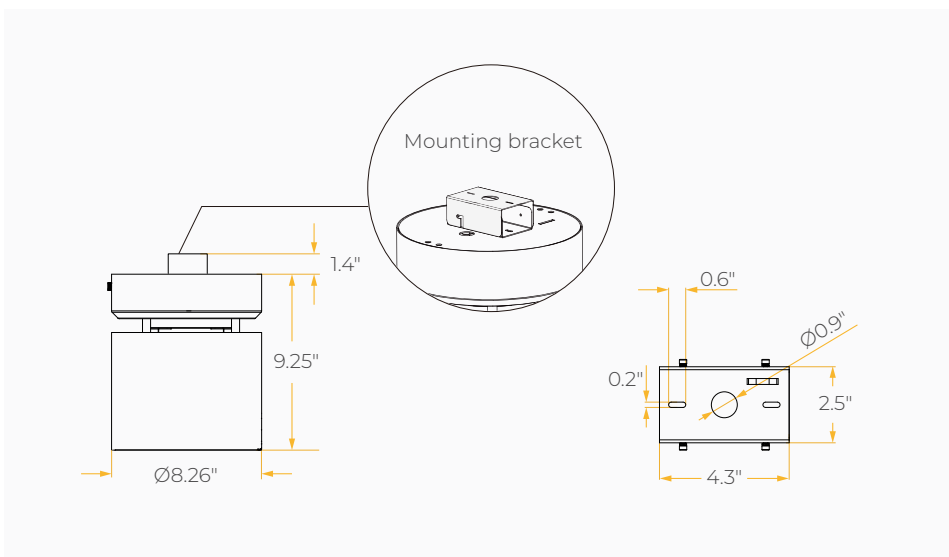

**DIMENSIONS**

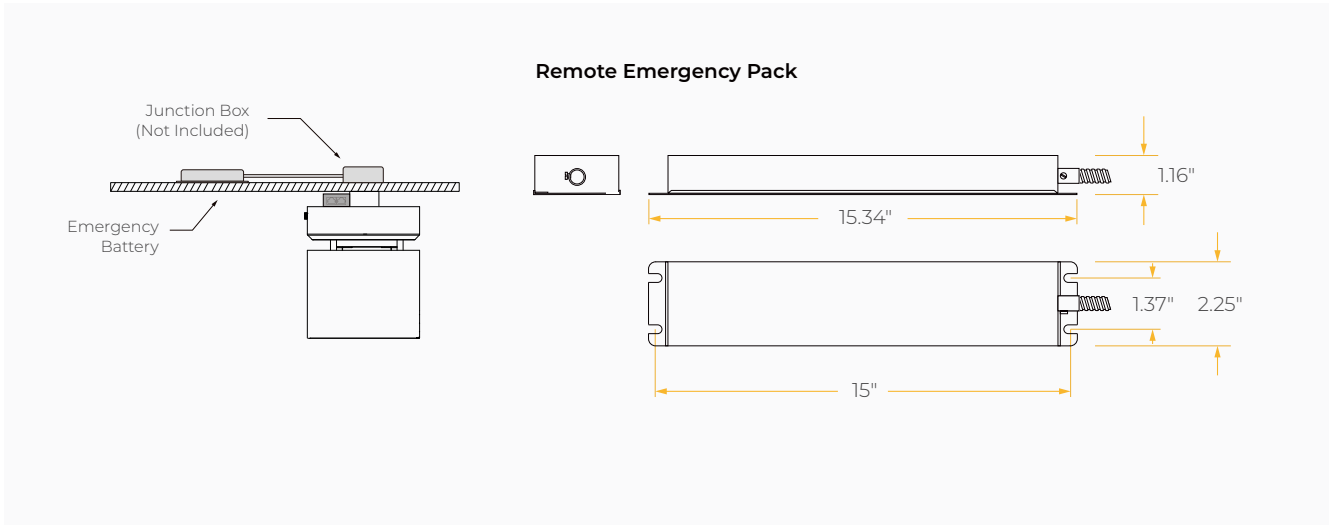

**MOUNTING OPTIONS\***

\*Junction Box not included

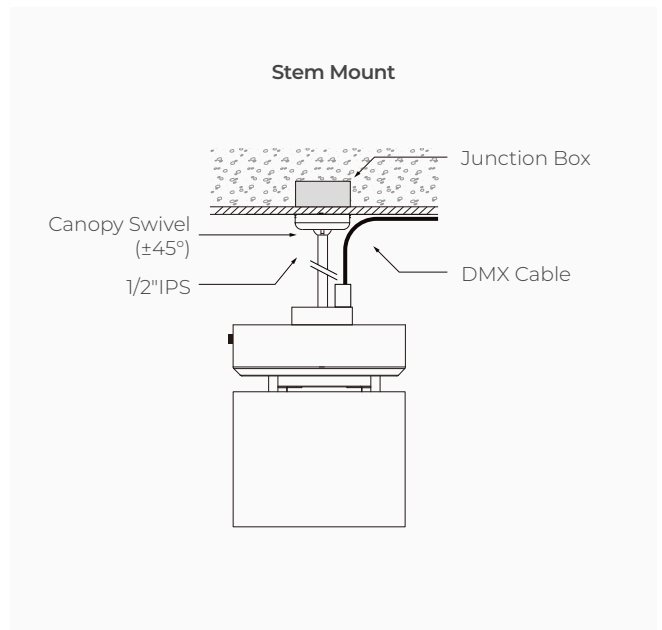
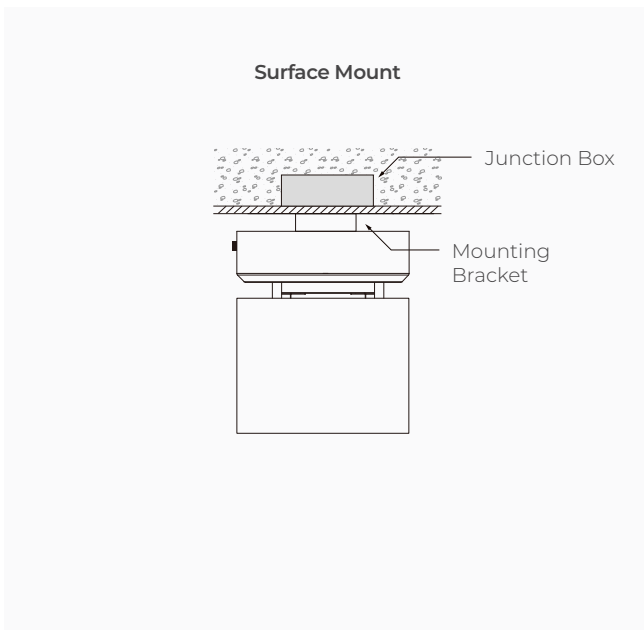

**MOUNTING OPTIONS\***

\*Junction Box not included

